

**315 MHZ**



# MPC-3 MK11 Heavy Duty OWNER'S HANDBOOK

Congratulations on the purchase of your New Generation B&D Controll-A-Door. This is a sophisticated unit using the latest microprocessor technology. You will appreciate the many features and high quality built into the product.

## SOME HELPFUL HINTS

- Note how to disengage the unit in case there is a power failure and you need to use the door manually. It is quite easy. (See page 3.)
- If you have a problem with the unit, please check the "LIGHTS FLASHING" (Page 13) or the "SYMPTOMS AND REMEDIES CHART" (Page 7). You may be able to save yourself a service call.
- Don't turn off at the power point, except for servicing.  
When going on holidays, it is recommended that the "SHUTDOWN" button be used rather than turning off at the power point.
- Do not allow water, or other liquids to enter the motor, wall unit or hand transmitter.
- Ensure the centre-lift lock on your B&D Roll-A-Door is UNLOCKED before operating your Controll-A-Door.
- Please read this booklet and keep it in a safe place for future reference.

## DOOR MAINTENANCE

Your B&D Controll-A-Door does not require any periodic servicing. However, the door to which it is fitted does so to ensure a long and trouble free life for your opener the following is recommended:

- **Once a Month** – disengage automatic opener and manually operate the door. If the door does not operate smoothly, call your authorised B&D Dealer.
- **Once a Year** – All doors require servicing approximately once per year. Contact your authorised B&D Dealer to conduct this service which will involve lubricating the springs, adjusting door tension and cleaning the guides.

WE STRESS THAT YOUR B&D CONTROLL-A-DOOR IS NOT A CHILD'S PLAYTHING, BE AWARE OF WHO MAY USE THE UNIT AND ENSURE THAT IT IS OPERATED WITH CARE AS INSTRUCTED.

**NSW Office:** B&D Australia, 34-36 Marigold Street, REVESBY 2212. Ph: (02) 9722 5555  
**QLD Office:** B&D Australia, 34-47 Cobalt Street, CAROLE PARK 4300. Ph: (07) 3271 2500  
**VIC Office:** B&D Australia, Canterbury Road, KILSYTH 3137. Ph: (03) 9237 7766  
**SA Office:** B&D Australia, 23 Frederick Road, ROYAL PARK 5014. (08) 8447 4747  
**WA Office:** B&D Australia, 225 Balcatta Road, BALCATT A 6021. (08) 9347 3239  
**TAS:** Tom Moore & Son, 86 Bass Highway, COOEE 7320. Ph: (03) 6431 4388

B&D Australia is a Division of Evans Deakin Pty Ltd  
A.B.N. 92 000 002 031

## HAND TRANSMITTER

Make sure the slide switch on the side is in the middle position. Press the button for 1 second to OPEN OR CLOSE the door.

## KEY-RING TRANSMITTER

Press the button for 1 second to OPEN OR CLOSE the door.

**IMPORTANT:** The range for the hand transmitter to reverse or stop the door is always less than to start the door.

- Always have the door in view when operating.
- Aim through the windscreen.
- Check that the door is fully closed before driving away

Pressing the hand transmitter or UP, STOP, DOWN while the door is going up will stop the door.

Next time the hand transmitter or UP, STOP, DOWN is pressed, the door will close.

## WALL CONTROL PANEL

Door position indicator and light display.

For Flashing Lights, see page 13.

For Code Setting, see page 4.

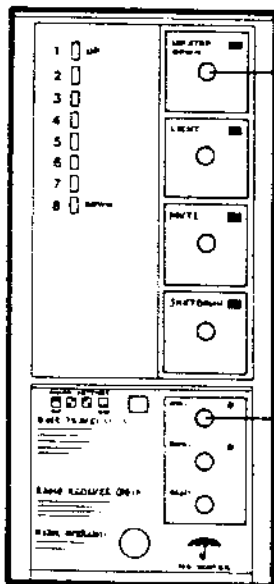

### UP, STOP, DOWN BUTTON

Touch to OPEN or CLOSE the door.



### LIGHT BUTTON

Touch to turn LIGHT ON (when Control-A-Door is not being operated). Touch again for OFF. Light automatically turns off after Control-A-Door operation.



### MUTE BUTTON

Touch to cancel beeps. Touch again to resume beeps. (For safety, the reversing warning beeps cannot be muted.)



### SHUTDOWN BUTTON

Touch to prevent Control-A-Door being operated. Touch again to resume normal operation.

## LOWER CONTROL PANEL

- To set limits of door travel. See page 4
- To set radio code. See page 4.
- Overload Reset. See page 13

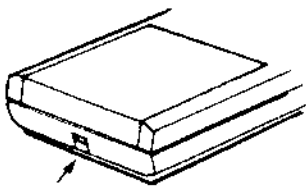

2

Push in, then lever

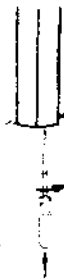

For access to Lower Control Panel use screwdriver as shown.

# POWER FAILURE

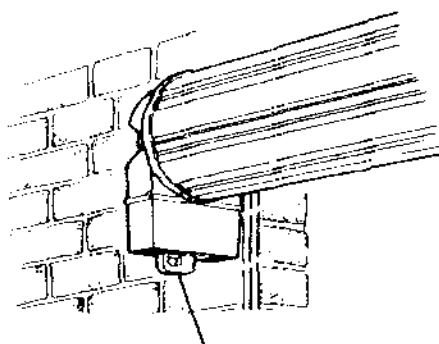

DISENGAGEMENT  
HANDLE

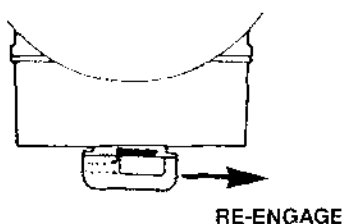
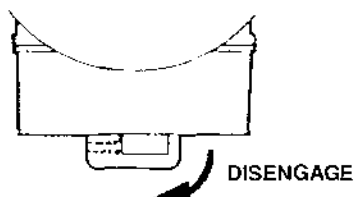

## HOW TO DISENGAGE YOUR CONTROLL-A-DOOR for MANUAL OPERATION

### TO DISENGAGE

Pull handle down firmly, then across to your left. The door can now be used manually.

### TO RE-ENGAGE

Move the handle towards the right.

### WHEN THE POWER RESUMES

The UP, STOP, DOWN light and No.2 light will flash. Your transmitter code will be remembered.

Make sure the drive unit is engaged.

Press UP, STOP, DOWN (or the hand transmitter).

Allow the Controll-A-Door to close fully. (This allows the Controll-A-Door to reconfirm its memory).

### WARNING: THE AUTOMATIC REVERSING SYSTEM WILL NOT OPERATE ON THE FIRST DOWN MOVEMENT!

If the door is already closed when UP, STOP, DOWN is pressed, or if there has been a short blackout while you have been out, the door will try to go down, then go up a short way and down again.

Press UP, STOP, DOWN (or transmitter) again and door will open normally.

# ACCESSORIES

KEY-RING  
TRANSMITTER

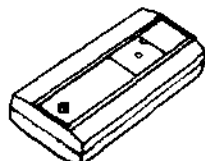
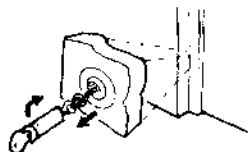

## WIRELESS REMOTE BUTTON & WIRED REMOTE BUTTON WITH LED

For fitting in the garage or inside the house.

## KEY SWITCH

For use outside the garage when transmitter is inconvenient.

## EXTERNAL DISENGAGEMENT DEVICE

Strongly recommended where the garage door is the only access to the garage. This allows the Controll-A-Door to be disengaged from outside the garage in case of power failure.

## ADDITIONAL HAND TRANSMITTERS

# PROGRAMMING

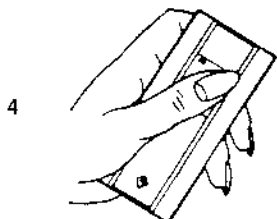
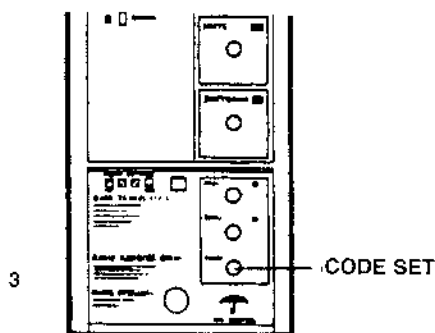
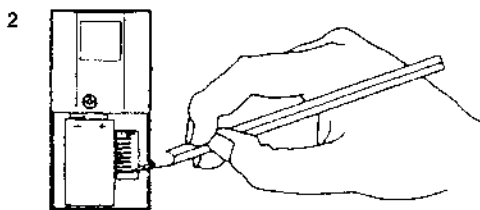
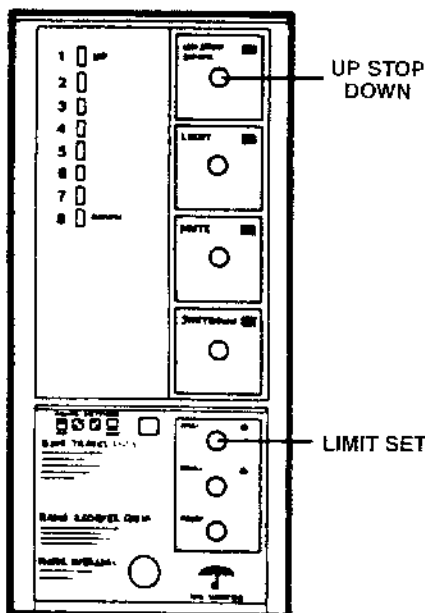

4

When your Controll-A-Door is installed it is "programmed" by the installer. The programming of the Controll-A-Door sets:

(i) The top and bottom limits of door travel, and (ii) Your own personal hand transmitter code.

Reprogramming will not normally be necessary unless you wish to change your transmitter code or change the open position of your door.

The Control-A-Door can be reprogrammed any time.

## HOW TO SET (OR CHANGE) THE TOP & BOTTOM LIMITS OF DOOR TRAVEL

1. Switch on power at the power point. Engage drive unit (page 3).
2. Remove the lower cover from the wall panel (see page 2).
3. LIMIT SET LED light should be on indicating that unit is in limit set mode. If the LED does not illuminate press the LIMIT SET button *once*.
4. Press and hold down UP. STOP. DOWN button to drive the door to the floor.
5. Press LIMIT SET button to accept lower limit. LIMIT SET LED light will now be flashing, indicating that lower limit has been accepted and the unit is ready to set the upper limit.
6. Press and hold UP. STOP. DOWN button to drive the door up to the desired limit. (3 cm below the headstop is recommended)
7. Press LIMIT SET button to accept the upper limit. LIMIT SET MODE LED light will extinguish, indicating both limits have been accepted.
8. Press UP. STOP. DOWN button to check the door operation.

*If the upper limits are not correct, finish the sequence to step 7 then gain from step 3.*

**NOTE:** The automatic reversing will reach maximum sensitivity after 3 downward operations.

## HOW TO SET (OR CHANGE) YOUR CODE

Your personal code can easily be changed as follows:

1. Set transmitter slide switch to CENTRE position.
2. Select your code on the hand transmitter. Set switches 1 to 8 in any combination of "-", "0" and "+" positions.
3. Press CODE SET. THE CODE SET LED will come on.
4. Press hand transmitter for 2 seconds. THE CODE SET LED will extinguish to show that a code has been received.

The Controll-A-Door is now ready for operation. Simply press the transmitter for half a second to operate.

# SERVICING

## HOW TO CHANGE LIGHT GLOBES

Bulb Type: 240V 40 watt candle, screw fitting ... available from B&D Dealers.

Close the door for better access to light diffuser.

Turn off at power point. Press light diffuser in at either end and tilt **away from handle**. Unscrew globes anti-clockwise and replace. Snap light diffuser back into place.

Make sure the door is engaged.

Turn the power back on, press UP, STOP, DOWN button and let the door close to reconfirm the memory.

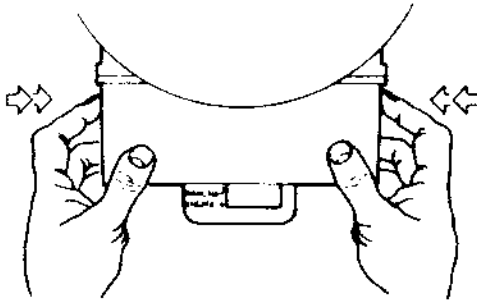

# MORE ABOUT YOUR CONTROLL-A-DOOR

## MEMORY

At the heart of your B&D Controll-A-Door is a unique Microprocessor. This stores vital information to control the door operation, such as: where the door should stop at the top and bottom, your code and details for the safety reversing system.

This information will be stored during power failures indefinitely.

## CARE OF THE CONTROLL-A-DOOR

Do not hose the wall unit or drive unit. Do not allow gutters to overflow onto the drive unit and do not allow water to run down the wall onto the wall control unit.

Water damage will invalidate warranty.



## AUTOMATIC REVERSING

Your B&D Controll-A-Door incorporates a unique reversing system. The Controll-A-Door will reverse instantly if an obstruction is encountered on the way down. A series of beeps will be sounded as a warning.

The computer controlled system provides reliable and sensitive reversing operation.

## AUTOMATIC LOCKING

When your Control-A-Door is in the down position, with drive unit engaged, the door is automatically locked with B&D's unique motor locking device. Even during power failure security is maintained.

The Controll-A-Door cannot be damaged by pressing the "wrong" buttons.

# MPC-3 MKII OWNER'S INSTALLATION INSTRUCTIONS

(To be read in conjunction with Roll-A-Door Installation Instructions)

PLEASE READ INSTRUCTIONS COMPLETELY BEFORE STARTING INSTALLATION.

## SUITS

- All Series I Nylofelt doors.
- All Series II Nylofelt doors up to 3000mm high
- All Series III Nylofelt doors.

## REQUIREMENTS

- Note: The door should be in reasonable operating condition and the maximum effort to move the door up or down, from stationary, should not exceed 200 Newtons (20kg force).
- For Series I doors with the round profile (manufactured prior to 1979), the guides should be replaced and a Guide Roller Kit fitted. This should be done by a B&D Dealer.

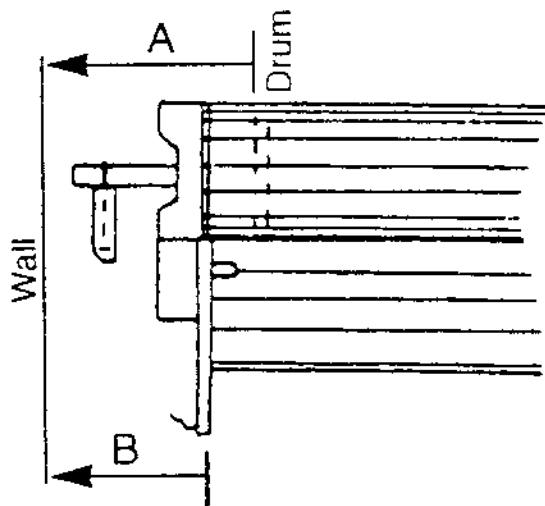

## MINIMUM SIDEROOM

**Dimension A** = 165 minimum  
(the distance from the wall to the drum).

**Dimension B** = 110 minimum  
(the distance from the wall to the curtain guide).

**The minimum sideroom must be greater than both A & B** whether the unit is fitted to left hand or right hand.

**NOTE:** The door bracket may have to be relocated to line up with the slots in the axle carrier.

These dimensions assume the drive unit will be fitted while the door is on the ground. If the door is already installed an additional 145mm clearance is required to slide the drive unit over the axle.

The chassis **must not** be cut down to reduce sideroom – the warranty is invalidated if this occurs.

## LEFT OR RIGHT HAND INSTALLATION

The new Control-A-Door can be fitted to the left or right hand side of the door (when looking from the inside the garage.) To set the "handedness" there are two switches on the back of the wall control unit.

For **LEFT HAND** installation set both **switches UP**.  
For **RIGHT HAND** installation set both **switches DOWN**.

# MPC-3 MKII OWNER'S INSTALLATION INSTRUCTIONS

## POWER SUPPLY

A 3 PIN 240 VOLT PROPERLY EARTHED POWER SUPPLY IS REQUIRED.

**WARNING!** A portable power generator should not be used. The Controll-A-Door may appear to malfunction due to fluctuations in the generated voltage

## POSITION

The drive unit and wall control should be mounted in a position out of the weather. Controll-A-Door is not designed for external use. Moisture may damage the unit and this is not covered by the Warranty.

## GENERAL ARRANGEMENT

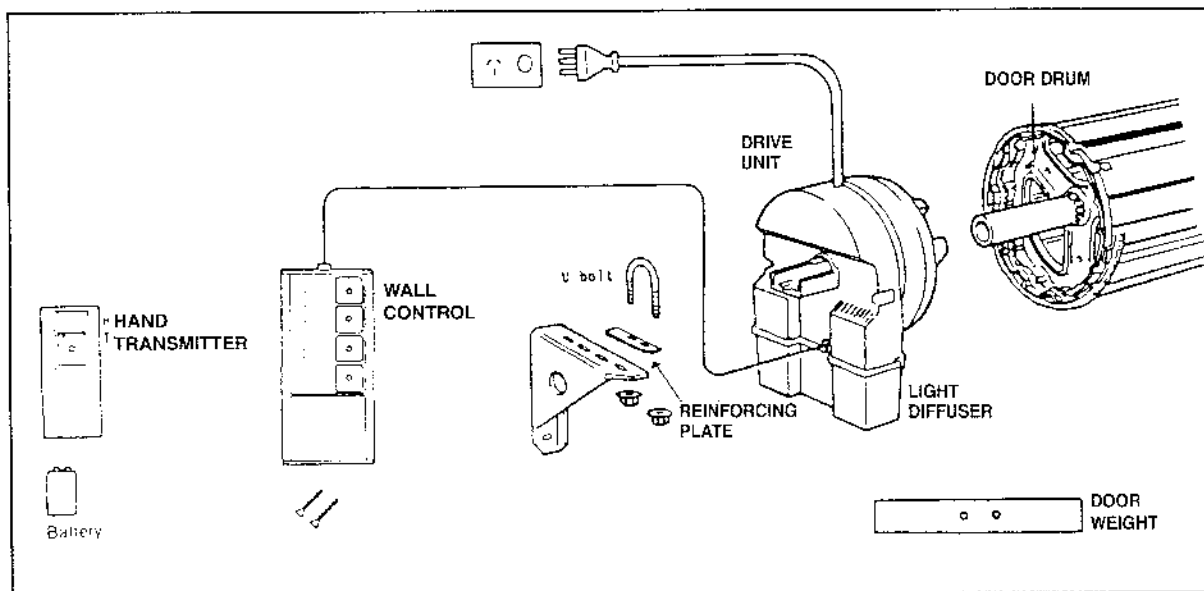

# INSTALLATION INSTRUCTIONS - Series I

(It is recommended that installation to Series II and Series III Doors be done by experienced door installers).

**WARNING!**  
STRONG SPRING TENSION

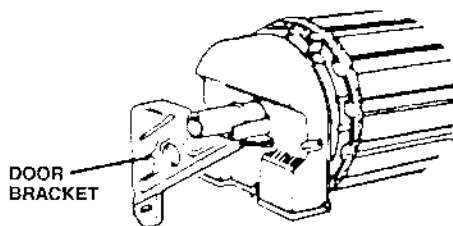
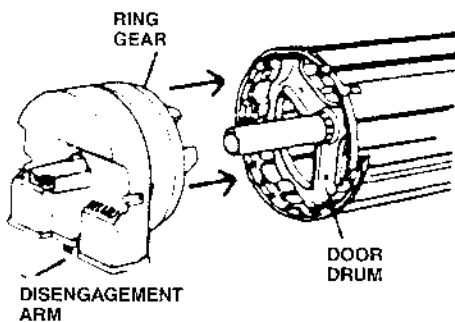
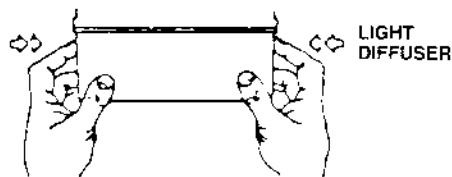
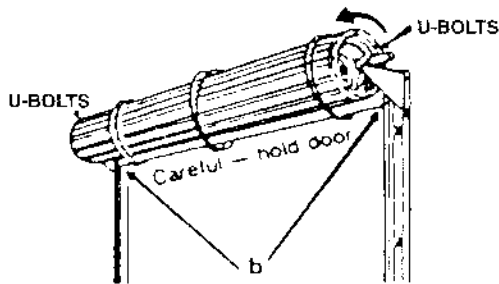

## 1. TAKE DOWN THE DOOR

(Alternative for experienced door installers: secure and support door. Take necessary safety precautions then remove bracket).

- Tie safety rope around centre of door. Careful - do not overtighten.
- Remove door stops.
- Carefully move door out of guides and tie 2 more ropes fairly tightly while holding door from spinning.  
★ **WARNING - STRONG SPRING TENSION!**
- Let door slowly rotate 1-2 turns (to release spring tension).
- Carefully loose, then remove the U bolts. Lift door down onto clean, padded floor.

## 2. FIT DRIVE UNIT

- Remove light diffuser.
- Disengage drive unit by pulling black plastic arm down and across, so that the ring gear can be rotated freely
- Slide drive unit over door axle so that it nests into door drum.

## 3. DOOR BRACKET

Check position to bracket and reposition if necessary. Refer to SIDEROOM requirements on previous page.

NOTE: Door brackets may need to be swapped over (L.H. - R.H.) to achieve sufficient sideroom. (Optimum as per diagram).



# INSTALLATION INSTRUCTIONS - Series I (Cont)

**REFER TO ROLL-A-DOOR INSTRUCTIONS (STEPS 3-6)  
FOR COMPLETE INSTRUCTIONS**

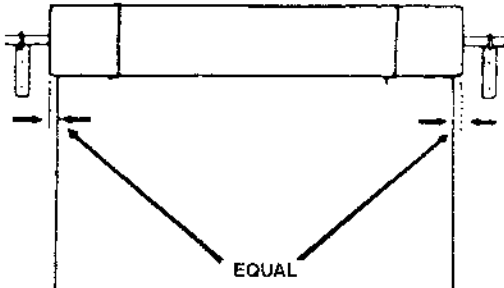

## 4. RE-FIT DOOR

- (a) Lift door onto brackets.  
Fit reinforcing plates, U-bolts, saddle and nuts.  
Make sure door overlaps equally both sides.
- (b) Securely tighten U bolts.

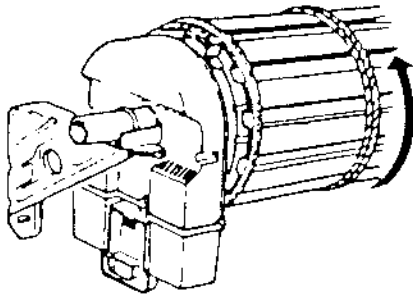

## 5. TENSION DOOR SPRINGS

- (a) Rotate 2 door turns in direction shown.
- (b) While firmly holding door, undo ropes and feed door into guides and refit door stops.

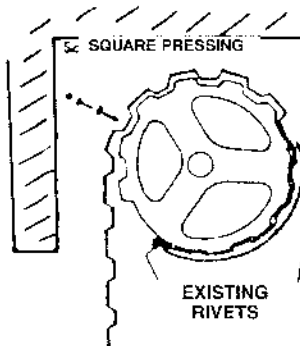

• While this screw should be positioned as low as possible, make sure that it does not alter the normal curtain to guide approach.

## 6. FIX DOOR CURTAIN

**IMPORTANT:** To achieve security when the Control-A-Door unit closes and locks, the door curtain must be fixed to the drum. With door fully closed:

- (a) Mark positions to drill as shown.
- (b) Open door slightly to get access to these positions.
- (c) Drill using  $\frac{1}{8}$ " drill.
- (c) Fix No. 10 x 32mm screws and washers to each drum.

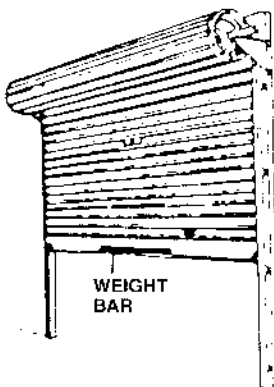

## 7. FIT WEIGHT BAR

- (a) Remove handle.
- (b) Fit weight bar and refit handle using screws supplied.
- (c) Adjust door tension so that door is evenly balanced.  
(Refer to Roll-A-Door instructions)

# INSTALLATION INSTRUCTIONS - Series I (Cont)

## REFER TO ROLL-A-DOOR INSTRUCTIONS (STEP 8)

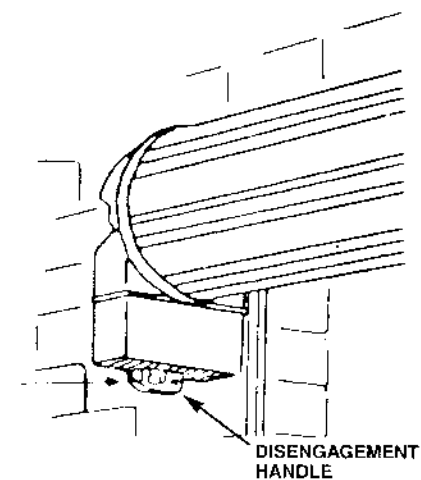
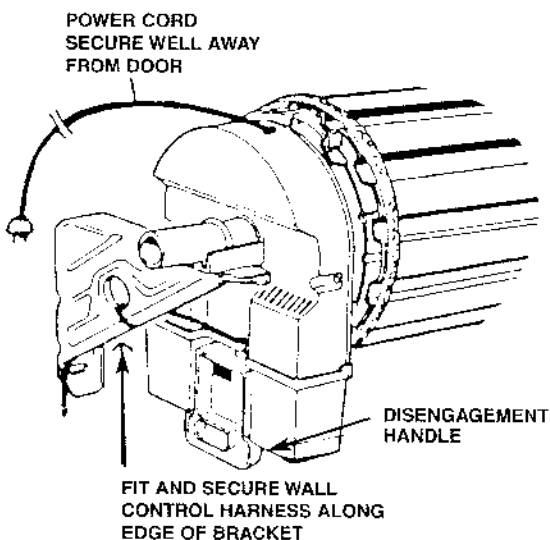

## 8. CHECK DOOR OPERATION

Door must be evenly balanced and smooth to operate. Rectify as per Roll-A-Door Installation Instructions, step 10.

## 9. FIT HANDLE, GLOBES, LIGHT DIFFUSER

With door closed .....

- (a) Fit disengaged handle.  
(Wording on handle must face inwards towards garage opening).
- (b) Carefully fit globes.
- (c) Fit light diffuser. Push up and snap into place.
- (d) Test disengagement and re-engagement operation.  
(Refer to Owners Handbook, page 3.)
- (e) Position wall control harness along angled edge of door bracket and secure with plastic tie (provided) through bracket hole.
- (f) Position power cord and secure it so that it is well away from moving parts of the door.

# INSTALLATION INSTRUCTIONS - Series I (Cont)

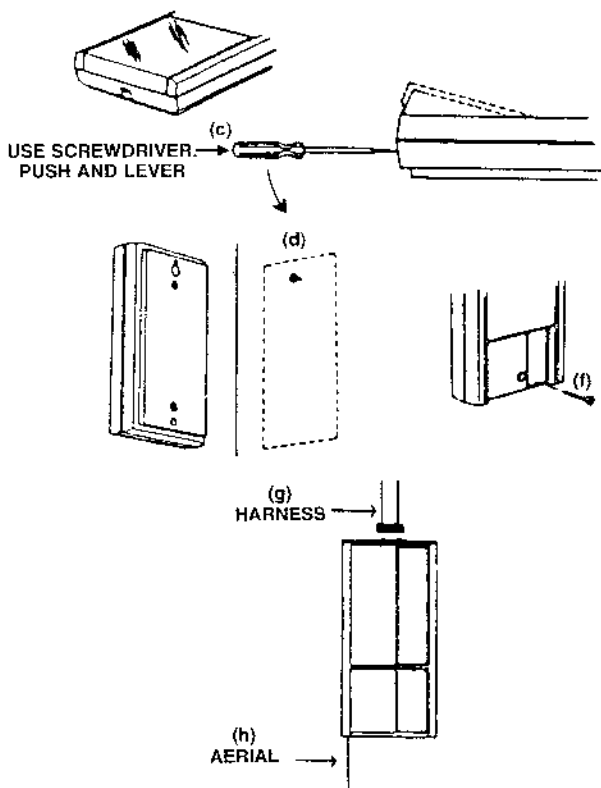

## 10. FIT WALL CONTROL PANEL

- Select position protected from the weather away from any metal objects (30cm minimum).
- Set LH/RH switches. See page 6.
- Remove lower cover. (Push screwdriver into slot and lever).
- Fix top screw, leaving head max. 2mm out from wall.
- Slip wall control slot over screw.
- Fix bottom screw.
- Make sure power is off, then plug in harness from drive unit.
- Untape and straighten the aerial wire so that it hangs straight down.

## 11. SET LIMITS OF DOOR TRAVEL

For the **initial** limit setting, before the manual switches have been adjusted, the limits should be set **MANUALLY**.

- Turn the power on. If the limit set light is not flashing, press Limit Set.
- Disengage the drive unit, close the door and press Limit Set to record the lower limit. (The Limit Set light will start flashing).
- Open the door to the desired position and press Limit Set to record the upper limit. The Limit Set light will go out and the unit will be in the normal operating mode.
- Re-engage the door.

**NOTE:** if the lower limit is accidentally set when the door is open, turn the power off and on again and start again.

# INSTALLATION INSTRUCTIONS - Series I (Cont)

## 12. SET DOOR TYPE/POWER SWITCHES

Set switches according to door type and size:

Setting 1.

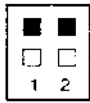

Series I doors  
up to 2400 high

Setting 2.

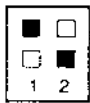

Series I doors  
over 2400 high

Setting 3.

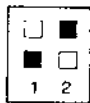

Series II & Series III doors  
up to 2400 high

Setting 4.

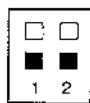

Series II & Series III doors  
over 2400 high

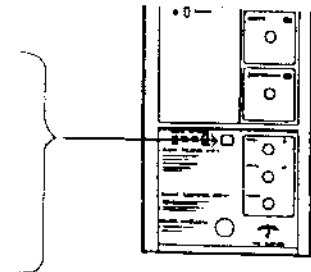

## 13. ADJUST THE POWER SETTING

The switch settings shown above (step 12) are approximate only. Time the door going up and then going down. THE TIMES SHOULD BE WITHIN 1 SECOND.

Change to the next less powerful setting if the time to go down is more than 1 second faster than the time to go up.

Change to the next more powerful setting:

- if the time to go down is more than 1 second slower than to go up.
- if the door reverses as it starts to go down.
- if the the door reverses because of low speed (2 beeps, lights 5 and 7 flash as it goes back up).

## 14. SET TRANSMITTER CODE COMBINATION AND PROGRAM INTO WALL CONTROL. (See Page 4)

## 15. REPLACE LOWER COVER ON WALL CONTROL.

## 16. FIT OPTIONS (Refer to separate instructions)

# LIGHTS FLASHING

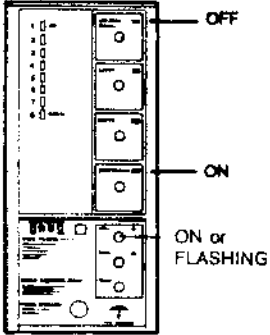
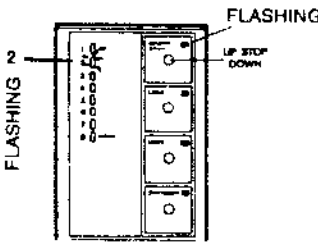
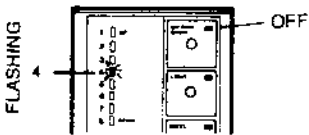
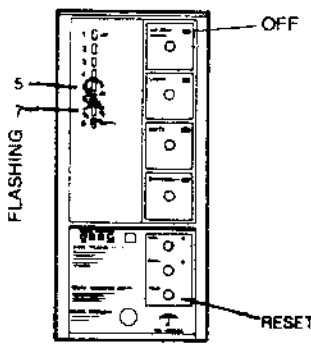
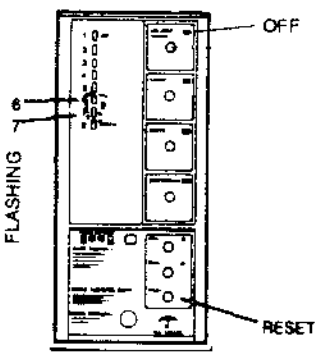
LIGHTS	WHAT IT MEANS	WHAT TO DO
 <p>Diagram of control panel with labels: OFF, ON, ON or FLASHING.</p>	<p>Limits for door travel and Code need to be set</p>	<p>Set Limits of door travel and set code. See page 4.</p>
 <p>Diagram of control panel with labels: FLASHING 2, UP STOP DOWN.</p>	<p>Power has resumed after the power has been off and the door needs to reconfirm its memory.</p> <p><b>WARNING: THE AUTOMATIC REVERSING SYSTEM WILL NOT OPERATE FIRST DOWN MOVEMENT.</b></p>	<p>Make sure the drive unit is engaged. Touch UP.STOP.DOWN button or Hand Transmitter Button and allow door to close fully. If the door is closed, it will move UP a short way and then close</p>
 <p>Diagram of control panel with labels: FLASHING 4, OFF.</p>	<p>The unit has cut out to protect the motor from overheating, after door has been operated too frequently.</p>	<p>Wait until No. 4 stops flashing (1/2 minute) and the green UP.STOP.DOWN light is on. Controll-A-Door is now operational.</p>
 <p>Diagram of control panel with labels: FLASHING 5, OFF, RESET.</p>	<p>The unit has cut out due to motor overload. Check:</p> <p>(a) Is the door free from obstruction?</p> <p>(b) Is the door correctly adjusted and running freely?</p> <p>If problem continues and no apparent fault can be found.....</p>	<p>Correct fault, PRESS RESET.</p> <p>Disengage drive unit and check door manually for smooth operation. Door may require service. When fault has been corrected, PRESS RESET.</p> <p>Call for Service.</p>
 <p>Diagram of control panel with labels: FLASHING 6, OFF, RESET.</p>	<p>The unit has failed to operate. Check:</p> <p>(a) Is the drive unit disengaged?</p> <p>(b) Is the centre lift lock locked?</p> <p>(c) Is the door jammed?</p> <p>If the problem continues and no apparent fault can be found</p>	<p>If so re-engage drive unit (page 3) and PRESS RESET.</p> <p>Unlock. Press RESET</p> <p>Rectify Problem. PRESS RESET.</p> <p>Call for service.</p>

# SAVE A SERVICE CALL

SYMPTOM	PROBABLE CAUSE	REMEDY
Door will not operate and: (a) no lights on wall control.	Power point off.	Turn on.
	Plug connection loose.	Check the harness connection to wall control. Check power plug.
(b) SHUTDOWN light is on.	Wall control is in SHUTDOWN mode.	Press SHUTDOWN to turn off.
(c) Some lights are flashing.		Refer to page 13.
(d) Motor ran but door did not move.	Drive unit DISENGAGED.	RE-ENGAGE. See page 3. If lights 6 & 7 flash, press RESET. If light 2 flashes, press UP, STOP, DOWN and let the door close fully.
Door operates from wall control but not from hand transmitter.	Battery in hand transmitter is flat.	Replace battery.
	Code is not set.	Set Code. See page 4.
	Transmitter slide switch not in middle position.	Set slide switch.
Transmitter range varies or is restricted.	Variations are normal depending on location and conditions.	See page 2 for correct use.
	Battery condition.	Replace as necessary.
	Aerial position.	Reposition for maximum range.
Light doesn't operate.	Globe blown.	Check and replace.
Door Travels too fast.	Power setting may be incorrect.	Call your B&D Dealer.
Door moved upward a short distance then closed.	Power has been turned off.	This is the normal sequence following a power failure, for the unit to reconfirm its memory. The door will now operate normally.
Door reverses for no apparent reason.	This occurs occasionally if the effort required to operate the door changes for any reason, such as extreme changes in weather conditions.	If the problem continues, call your B&D Dealer.
If problem continues	Door guides damaged.	Repair guides or call your B&D Dealer.
Door reverses off floor.	Control-A-Door Installation problem.	Call your B&D Dealer.
Door roll 'grows large' when closing.	Door not correctly adjusted.	Service Door
	Door guides may have excessive friction.	Clean inside faces of guides. Do not put oil, grease, sprays of any kind, polish or talc in the guides.
	Bottom rail weight insufficient.	Call your B&D Dealer.
Door opens on its own.	A neighbour may have the same transmitter code.	Change your transmitter code and enter it onto the wall control. See page 4.
Motor sound changes when the door is nearly opened.	This is normal on all MPC-3 Control-A-Doors on double garage doors.	No cause for concern.

# WARRANTY

- A. The Manufacturer, B&D Australia (NSW), a member of Evans Deakin Pty Ltd ("B&D") of 34-36 Mawgoli Street, Newcastle subject to the terms set out herein, hereby warrants to the original retail purchaser ("the Buyer") that the B&D Control A Door ("the Unit") including every major component part thereof will be free from defects in materials and workmanship in normal use, service and operation:
- (i) for a period of (2) years:
    - (a) where the residential unit is installed in and for the purposes of domestic or residential applications, and
    - (b) where the industrial unit is installed in and for the purposes of industrial or commercial applications, or
  - (ii) for a period of (3) months:
    - (a) where the residential unit is installed in and for the purposes of industrial or commercial applications and
    - (b) where the industrial unit is installed so that it is subject to over one thousand (1000) operations in any 3 months.
- Such warranty periods shall run from the date of delivery of the Unit where delivery is effected by B&D or one of its Authorised Distributors listed in the Owner's Handbook supplied with the Unit or from the date of purchase in any other case.
- B. (i) Notwithstanding anything herein where the Unit has been installed by B&D or an Authorised Distributor, the period of warranty provided for in paragraph A above shall run from the date of such installation and the Buyer shall be entitled to free service by B&D or its Authorised Distributor to remedy any defects covered by this warranty. The Buyer will pay for any service call made by B&D or its Authorised Distributors when in the opinion of B&D these calls are made for the purpose of adjustment which is described in the Owner's Handbook.
- (ii) Where the unit has not been installed by B&D or an Authorised Distributor, B&D in addition to any warranty which may be offered by the party who installed the Unit, will within a reasonable period of time after notification of the defect by the Buyer and on return of the defective part or Unit to B&D repair or, at its option, replace any defective part or Unit covered by this warranty without charge provided that all costs of disconnection, reinstallation and freight shall be borne by the Buyer.
- C. **Notification and Proof to be given by the Buyer**  
In the event of any defect in the Unit arising, the Buyer must notify directly either B&D at the above address or an Authorised Distributor and must establish to the reasonable satisfaction of B&D or such Distributor the date of purchase or installation (as the case may be) by way of invoice or installer stamp on the Warranty Form contained in the Owner's Handbook.
- D. **Future Modifications**  
B&D may make such modifications to any existing or future models of the Unit as it may deem necessary without incurring any obligation to incorporate such modifications in Units previously sold or to which this Warranty may relate.
- E. **General**  
Subject to paragraph F below, the obligations of B&D or an Authorised Distributor under this Warranty are limited to those contained herein and this Warranty is the only warranty made by a person authorised by B&D in writing and is exclusively and expressly in lieu of all other warranties permitted to be excluded by law whether those warranties are express, implied, under the common law or by statute and the terms of this Warranty may not be modified by any person, firm or corporation other than B&D.
- F. **Exclusions**  
Notwithstanding the terms herein but subject to paragraph H herein, this Warranty shall not apply and B&D or its Authorised Distributors will be relieved of all obligations, responsibilities and liabilities (direct or consequential) in the event that defects in or malfunctions of the Unit are directly or indirectly in the opinion of B&D due to or result from:
  - (i) lack of proper maintenance or care of the Unit;
  - (ii) incorrect or unreasonable use;
  - (iii) faulty installation or adjustment of the Unit or door to which the Unit is connected where such installation or adjustment is not carried out by B&D or one of its Authorised Distributors;
  - (iv) failure to observe any instructions or directions provided with the Unit or given to the Buyer by the installer;
  - (v) modifications or repairs made or attempted to be made by any person not Authorised by B&D;
  - (vi) faulty electrical wiring of structures to which the Unit is affixed; or
  - (vii) radio (including citizen band transmissions) or other electronic interference.Notwithstanding the terms herein but subject to paragraph H, this Warranty:-
  - (a) does not apply when the Unit is supplied with or fitted to any door or other closing device which is not manufactured or sold as an authorised B&D door or, where it is an authorised B&D door, is not of the type or condition specified as suitable for installation of the Unit in the Owner's Handbook Annex, Installer's Instructions, at page 3; and
  - (b) does not cover and shall not relate to batteries or globes supplied with the Unit and B&D or its Authorised Distributors shall not be liable for any defect, malfunction or failure of such items.
- G. This warranty constituted by paragraphs A to F above shall apply only to purchasers who are Australian residents. In the case of original retail sales to persons other than Australian residents, B&D, subject to paragraph H below, limits its liability absolutely to the extent permitted by the law.
- H. **Statutory Warranties**  
IT IS EXPRESSLY PROVIDED THAT THIS WARRANTY OR ANY TERMS AND CONDITIONS OF IT OR OTHER STATEMENT CONTAINED IN THIS DOCUMENT THE OWNER'S HANDBOOK OR OTHER LITERATURE GIVEN TO THE BUYER SHALL NOT BE READ OR APPLIED SO AS TO PURPORT TO EXCLUDE, RESTRICT OR MODIFY OR HAVE THE EFFECT OF EXCLUDING, RESTRICTING OR MODIFYING THE APPLICATION IN RELATION TO THE SUPPLY OF THE "UNIT" OR ALL OR ANY OF THE PROVISIONS OF DIVISIONS 2 AND 2A OR PART V OF THE TRADE PRACTICES ACT, 1974 ("THE ACT") AS AMENDED OR THE EXERCISE OF A RIGHT CONFERRED BY SUCH A PROVISION OR ANY LIABILITY OF B&D OR ITS AUTHORISED DISTRIBUTORS FOR BREACH OF A CONDITION OR WARRANTY IMPLIED BY SUCH PROVISIONS OR ANY OTHER CONDITIONS OR WARRANTIES IMPLIED BY AND RELEVANT STATE ACT OR TERRITORIAL ORDINANCE OR BY THE GENERAL LAW AND WHICH BY LAW CANNOT BE EXCLUDED OR RESTRICTED OR MODIFIED PROVIDED THAT TO THE EXTENT THAT THE ACT PERMITS B&D TO LIMIT ITS LIABILITY FOR A BREACH OF A CONDITION OR WARRANTY IMPLIED BY THE ACT THEN B&D'S LIABILITY FOR SUCH BREACH SHALL BE LIMITED TO THE PAYMENT OF THE COST OF REPLACING THE GOODS OR ACQUIRING EQUIVALENT GOODS OR OF REPAIRING THE GOODS.
- I. **RE-SUPPLIER INDEMNITY**  
This warranty shall not apply to any person or body other than the original retail purchaser of any Unit from B&D or its Authorised Distributor. Except to the extent provided herein, B&D or its Authorised Distributors shall have no liability (including liability in negligence) to any person or body for any loss of damage consequential or otherwise, howsoever suffered or incurred, by any such person or body in relation to the Units or the services provided in respect of the Units and without limiting the generality thereof, in particular any loss or damage consequential or otherwise howsoever suffered or incurred by any such person or body, caused by or resulting directly or indirectly from the supply of services or from any failure, breakdown, defects or deficiency of whatsoever nature or kind in the Units.

## FILL THIS IN NOW FOR YOUR RECORD

Name: .....

Address: .....

Purchased from: .....

Installed by: .....

Installed on (date): .....

(Onus on owner for proof of purchase date)

PATENTS AND REGISTERED DESIGNS APPLIED FOR: Driving arrangement, Drive unit, Disengagement mechanisms, Electronic programme, limit setting, code setting, solenoid locking, Ring gear, Drive Unit cover, Lamp housing, Chassis, Hand Transmitter.

15